



CHW 6217 AGB

You can rely on Defy. To simplify.

**COOKER HOOD
600 ANGLED GLASS**

Users Manual

Record in the space below the listed information for future reference.

SERIAL NUMBER.....

DATE OF PURCHASE.....

PURCHASED FROM.....

.....

Introduction

Dear Customer,

Congratulations on the purchase of your new Defy appliance.



Please read this manual carefully before using your appliance for the first time and then store it within easy reach for future reference.

This manual will provide you with information on how to operate and care for your appliance to gain the maximum benefit from it.

We trust you will enjoy years of trouble free use.

SAVE THESE INSTRUCTIONS

EXPLANATION OF SYMBOLS

| | |
|--|--|
|  | Important information or useful hints about usage. |
|  | Warning for hazardous situations with regard to life and property. |
|  | Warning for electric shock. |

| | |
|--|---|
|  | The manufacturer strives for continuous improvement. For this reason, the text and illustrations in this manual are subject to change without notice. |
|--|---|

Index

- 4 Important safety instructions.**
- 4 General safety.**
- 5 Safety for children.**
- 6 Safety when working with electricity.**
- 7 Electrical connection.**
- 7 Description.**
- 7 Before use.**
- 7 Mode of operation.**
- 8 Installation.**
- 11 Control Panel.**
- 12 Maintenance and cleaning.**
- 14 Owner's responsibility.**
- 15 Service Centres.**
- 16 Warranty.**

Important safety instructions



This section contains safety instructions that will help you avoid risk of injury and damage. All warranties will be void if you do not follow these instructions.

This appliance is intended to be used in household and similar applications such as:

1. Staff kitchen areas, in shops, offices and other working environments
2. Farm houses;
3. By clients in hotels, motels and other residential type environments;
4. Bed and breakfast type environments

General safety

- This cooker hood is not intended for use by persons (including children) with reduced physical, sensory or mental capabilities or lack of experience and knowledge, unless they have been given supervision or instruction concerning the use of the cooker hood by a person responsible for their safety.
- Children must be supervised to prevent them from tampering with the cooker hood.
- Cleaning and user maintenance must not be done by children without supervision.
- Do not operate the cooker hood if it is defective or has any visible damage.
- Do not carry out any repairs or modifications on the cooker hood.
- Never wash down the cooker hood with water! There is a risk of electric shock!
- Never use the cooker hood when your judgment or coordination is impaired by the use of alcohol and/or drugs.
- The cooker hood must be disconnected from the mains during installation, maintenance, cleaning and repair procedures.
- Do not place any flammable materials close to the cooker hood.
- Make sure that the cooker hood function knobs are switched off after every use.
- Switch off the power at the mains in the event of a fault or when cleaning the cooker hood.
- Do not check the status of the filters while the cooker hood is operating.
- Never operate the cooker hood without a filter.
- This cooker hood complies with all relevant safety regulations.

- Never leave cooking fat or oil unattended. Overheated fat or oil can easily catch fire.
- Do not flambé food directly under the cooker hood. The flames pose the risk of the filter catching fire.
- Restrictions apply to the use of the cooker hood over a solid fuel or gas stove.
- Observe the minimum distance between the supporting surface for cooking vessels on the hob and the lowest part of the cooker hood. (When the cooker hood is located above a gas appliance, this distance shall be at least 65 cm).
- Regulations concerning the discharge of air must be fulfilled.
- The air must not be discharged into a flue that is used for exhausting fumes from appliances burning gas or other fuels.
- There must be adequate ventilation of the room when the cooker hood is used at the same time as appliances burning gas or other fuels.
- Do not touch any part of the light fittings or adjacent areas during or straight after prolonged use as they get very hot and could cause severe burns.
- In certain circumstances electrical appliances may be a hazard.
- Avoid leaving exposed flames unattended and always ensure that the burners are covered as open flames are damaging for the filters and a fire hazard.
- Constantly check food frying to avoid overheated oil becoming a fire hazard.
- There is a risk of fire if cleaning is not carried out in accordance with the instructions.
- Do not use with a programmer, timer, separate remote-control system or any other device that switches on automatically.





CAUTION: Accessible parts may become hot when used with cooking appliances.

Safety for children

- Electrical products are dangerous to children. Keep children away from the cooker hood when it is operating and do not allow them to play with the cooker hood.
- Packaging materials are dangerous for children. Keep packaging materials away from children. Please dispose of all parts of the packaging in a responsible manner.
- Plastic bags should be cut up to prevent children playing with them and accidentally suffocating.

Safety when working with electricity

- Connect the cooker hood to an earthed outlet/line protected by a fuse of suitable capacity. Have the earth installation made by a qualified electrician. This cooker hood must be earthed and the manufacturer and the seller do not accept responsibility for any damage due to incorrect installation or electrical connection.
- If the supply cord is damaged, it must be replaced by the manufacturer, its service agent or similarly qualified persons in order to avoid a hazard.
- Defective electric equipment is one of the major causes of house fires.
- Any work on electrical equipment and systems should only be carried out by authorized and qualified persons.
- In case of any damage, switch off the cooker hood and disconnect it from the mains. Report the damage to your dealer, who will take the necessary corrective action.

| | |
|--|--|
|  | Warning: The manufacturer shall not be liable for any damage caused by improper use or handling errors. |
|  | Warning: Damaged power cables must be replaced by an Authorized Service Agent. |

Electrical connection

- The cooker hood uses a 220-230V~ / 50Hz power supply.
- If the mains power cord is damaged, it must be replaced by a qualified electrician.
- The power cord is located in the chimney area. Should you require an installation with no visible wiring, a 15 amp earthed plug socket should be accessible either in the ceiling above the cooker hood or on the wall behind the chimney area. (A qualified electrician must provide this facility).
- **The cooker hood must be earthed. The manufacturer and the seller do not accept responsibility for any damage due to incorrect electrical connection.**
- **This cooker hood may not be used with a battery inverter power supply.**

Description

- The cooker hood fan extracts the kitchen vapours and passes them through the filter.
- The filter absorbs the solid particles in the cooking vapours, keeping the kitchen almost free of grease.

Before use

Before using your new cooker hood for the first time, please read this manual carefully. It contains important information concerning your personal safety as well as on the use and care of the cooker hood.

- Remove all packaging (except any protective film on the cooker hood if applicable) and dispose of it in an environmentally friendly manner.
- If the cooker hood is damaged in any way, do not use it. Report the damage to your dealer, who will take the necessary corrective action.

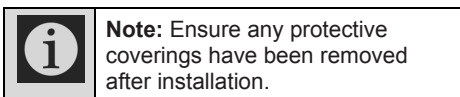

Mode of operation

The appliance has been designed as either an air extractor (The air is drawn in and cleaned by the aluminium filter and directed outside through an exhaust pipe with 150mm diameter (not included with the product) or as an air re-circulator (The air is drawn in and cleaned by a carbon filter (not included with the product)).

To work as an air extractor; your cooker hood can be installed as per the below diagram.

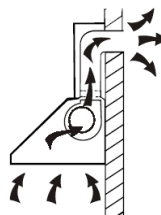

To work as an air re-circulator; your cooker hood can be installed as per the below diagram.

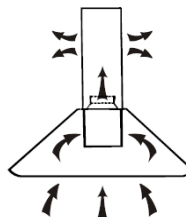

Installation

Installation dimension

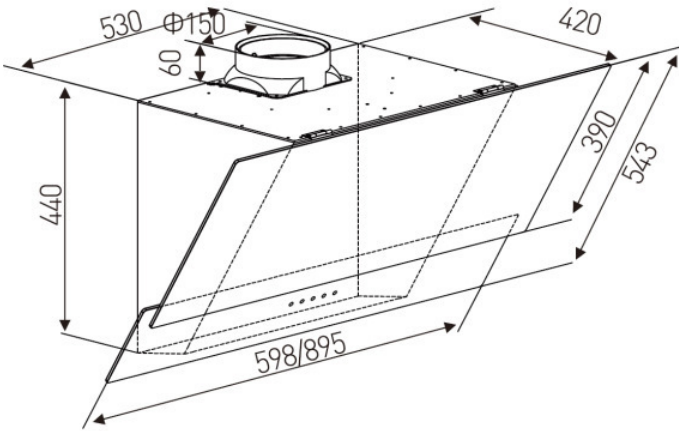

1. The cooker hood should be placed at a distance of 65-75cm (26-30 inch) from the cooking surface for the best effect. See Image 1.
2. Install the wall plugs at a suitable place once the installation height is fixed, and keep it in line, see Image 2.
3. Install the outlet and exhaust pipe onto the cooker hood by screws, see Image 3.
(Note: The exhaust pipe has a 150 mm diameter and is not supplied with the product).
4. Install the chimney bracket on the chimney, see Image 4.
5. Adjusting the cooker hood position, fix the cooker hood with screws (safety screw), See Image 5.
6. Adjust the position of the chimney and fix it by screws. See Image 6.

| | |
|---|---|
|  | Warning: Failure to install the screws or fixing device in accordance with these instructions may result in electrical hazards |
|---|---|

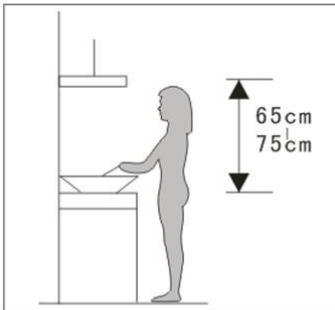

Image 1

Note: The two safety vents are positioned on the back casing, with a diameter of 6 mm.

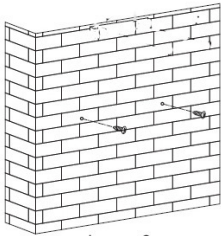

Image 2

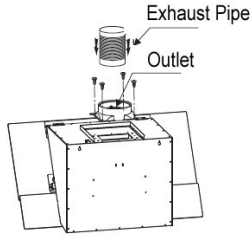

Image 3

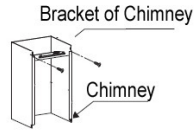

Image 4

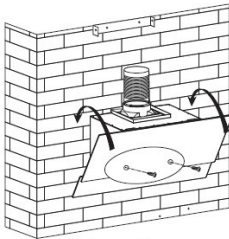

Image 5

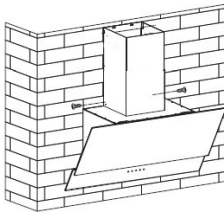

Image 6

- Any installation work must be carried out by a qualified electrician or competent person.
- Do not connect the ducting system of the hood to any existing ventilation system which is being used for any other appliances burning gas or other fuels.
- The angle of the bend of the ventilation pipe should not be less than 120°; you must direct the pipe horizontally, or, alternatively, the pipe should go up from the initial point and should be led to an outer wall.

- After the installation is complete, make sure that the cooker hood is level to avoid grease collection at one end. See Image 7.

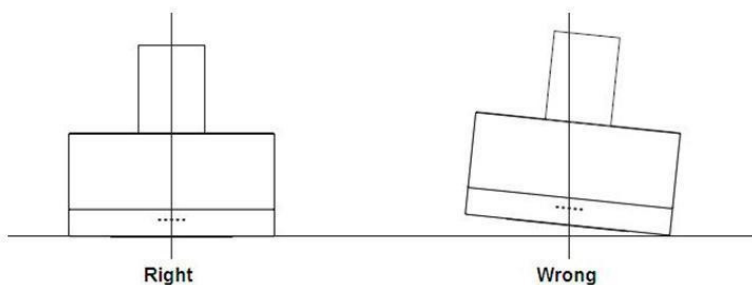
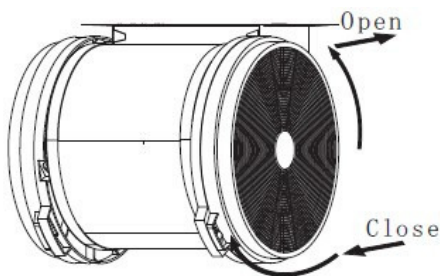

Image 7

Installing carbon filters

Remove the air filter then install the carbon filters (not supplied).



Attach the AI filter to the hood after installing the carbon filters.





NOTE: The carbon filters must never be washed and should be replaced every 3 months.





| | |
|--|--|
|  | Should you require them, factory approved, carbon pad filters and installation kits may be purchased from your nearest Defy Service Centre or their authorised agents. |
|--|--|

Control panel



Image 8

The touch control has five functions:  (Low),  (Mid),  (High),  (Light),  (Timer). See image 8.

1. Power on: Switch on the power supply, and the backlight is lit. And it will turn off after 5 seconds if without any operation, then the hood enters stand-by mode.
2. Touch  button once; lights will be on .Touch  button again; lights will be off.
3. Touch the low speed button  once, the motor will run at low speed. Touch it again, the motor will stop.
4. Touch the Mid speed button  once, the motor will run at mid speed. Touch it again, the motor will stop.
5. Touch the high speed button  once, the motor will run at high speed. Touch it again, the motor will stop.

While the hood is working, touch the timer button  once, the hood will power off automatically after 5 minutes.



Figures in this manual are schematic and may not exactly match your product.

Maintenance and cleaning



WARNING: Before cleaning any part of the hood, switch the power off at the mains. Ensure that it is switched off at the wall socket and plug is withdrawn

Cleaning the air filter

In normal operation (1 to 2 hours daily), the filters must be cleaned every 8 to 10 weeks. The air filter is made of high-density aluminium. Please do not use a corrosive detergent on it. Keeping this filter clean will keep the appliance operating correctly. Please follow the guideline below.

1. Put the air filter into clean water at a temperature of about 40°C to 50°C.
2. Pour the detergent on the air filter and soak for approximately 3 minutes.
3. Wear gloves and gently clean it with a soft brush.



Do not apply too much pressure when cleaning the air filter as the air filter is delicate and too much pressure will cause damage to it.

Cleaning the hood

- All external surfaces and controls can be cleaned using a little washing-up liquid applied with a soft sponge or cloth. Wipe dry using a soft cloth.
- Only use a damp cloth as water could get into the unit and cause damage.
- Do not use cleaning agents containing soda; acids; chlorides or solvents.
- Do not use abrasive cleaning agents; e.g. powder cleaners or cream cleanser and abrasive sponges; as well as pot scourers or sponges which have been used previously with abrasive cleaning agents as these will damage the surface material.



Keep the motor and other parts free from water, as this will cause damage to the appliance.

WARNING: There is a fire risk if cleaning is not carried out in accordance with these instructions.

General cleaning. (Stainless steel)

Stainless steel is not adversely affected by normal household use but because of its reputation for durability, it is sometimes assumed to be indestructible, and therefore subjected to misuse or even abuse. Care should be taken to avoid such 'abnormal use'.

Cleaning materials. (Stainless steel)

Do use:

- A moist lint free soft cloth or synthetic sponge.
- Soap, or mild liquid detergent.
- A mild window cleaner.
- Diluted ammonia in warm water.
- A nylon bristle brush.
- Cleaners labelled "Suitable for stainless steel".

Do not use:

- A steam cleaner.
- Acid, alcohol, soda, chloride or spirit based cleaners.
- Coarse abrasive cleaning powders.
- Metallic scourers, steel wool, metal scrapers, or plastic scouring pads.
- Wire brushes or emery paper.
- So called "silver cleaners".

Cleaning procedure

- Frequent cleaning is recommended rather than an occasional aggressive clean.
- Routine cleaning will preserve the corrosion resistance and the appearance of the stainless steel for many years.
- Clean the stainless steel as often as necessary (i.e. when it is noticeably dull or dirty) and use the simplest cleaning method that will effectively do the job.
- Use clean water, or a mild detergent solution applied with a soft cloth or sponge. Rinse well and wipe dry.
- Always wipe in the direction of the brushed texture on the stainless steel.
- Periodically apply a fine film of dedicated stainless steel cleaner or baby oil to the canopy of the extractor hood to add lustre and sparkle to the steel.

Replacing the lamp

1. Disconnect the electricity supply.
2. Remove the lamp cover ring and the glass
3. Replace with a 20W 12V halogen light. (G4 20W Max).

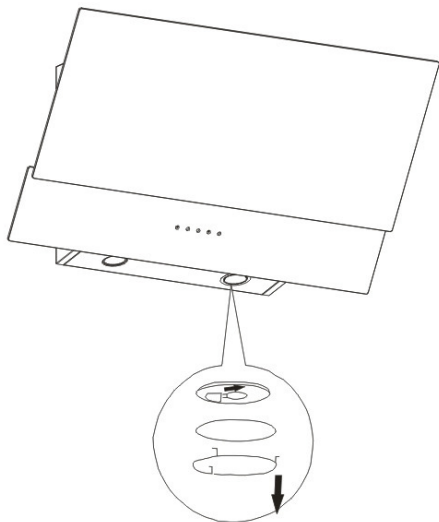

| | |
|--|--|
|  | CAUTION: Do not touch bulbs with your bare hands. |
| | Warning: Please make sure you hold the cover ring and glass securely at all times when handling them. |

Before and after use

We recommend that the cooker hood is switched on before any food is cooked. We also recommend that the cooker hood is left running for 15 minutes after the food is cooked, in order to thoroughly eliminate all contaminated air. The effective performance of the cooker hood depends on constant maintenance.

Optional Carbon pad filters

- Carbon pad filters assist in removing any unwanted cooking odours from the atmosphere.
- If your installation ducts filtered air to the outside, the carbon pad filters are not required.
- Should you require them, factory approved, carbon pad filters and installation kits may be purchased from your nearest Defy Service Centre or their authorised agents.

The Carbon pad filters are used to purify the air which is released back into the room.

Carbon filters are not washable or re-usable and must be replaced at least once every three months. The active carbon filter saturation level depends on the frequency with which the appliance is used, the type of cooking performed and the regularity with which the anti-grease filters are cleaned.

| | |
|--|--|
|  | Exhaust pipe and carbon filter are not supplied together with the product. |
| | Factory approved, carbon pad filters, exhaust pipes and installation kits may be purchased from your nearest Defy Service Centre or their authorised agents. |
| | The carbon filters must not be exposed to heat. |

Owner's responsibility

NOTE: Since the following are not factory faults, they are the owner's responsibility.

- Damage to exterior finish.
- Breakage of glass and other components.
- Replacement of the light bulbs.
- Damage through improper use or installation.

Problem check

Before calling a service technician to assist with a problem please check:

- The main distribution board. See if a circuit breaker has tripped or a fuse has blown.
- The wall socket.
- Have the filters been cleaned?
- Is the chimney blocked?

Remember that you may be charged for a service call even during the warranty period if the fault is due to or caused by any of the above.

PLEASE REGISTER YOUR PRODUCT AT

www.defy.co.za

DEFY APPLIANCES (PTY) LTD

P.O.BOX 12004

JACOBS

DURBAN

4026

SOUTH AFRICA

Service Centres

South African Service Agents:

BLOEMFONTEIN

160 Long Street, Hilton, Bloemfontein 9301
Tel: 051 400 3900
Bloemfontein.Service@defy.co.za

CAPE TOWN

5A Marconi Rd. Montague Gardens, 7441
Tel: 021 526 3000
CapeTown.Service@defy.co.za

DURBAN

35 Intersite Avenue, Umgeni Business Park,
Durban, 4051
Tel: 031 268 3300
Durban.Service@defy.co.za

EAST LONDON

16 Bowls Rd. Arcadia, East London, 5201
Tel: 043 743 7100
EastLondon.Service@defy.co.za

JOHANNESBURG

Cnr. Mimetes & Kruger Sts. Denver ext.12
Johannesburg, 2094
Tel: 011 621 0200 or 011 621 0300
Gauteng.Service@defy.co.za

POLOKWANE

87 Nelson Mandela Drive, Superbia 0699
Tel: 0152 92 1166 / 7 / 8 / 9
Polokwane.Service@defy.co.za

PORT ELIZABETH

112 Patterson Road, North End, Port Elizabeth
6001
Tel: 041 401 6400
PortElizabeth.Service@defy.co.za

PRETORIA

Block A1 Old Mutual Industrial Park,
Cnr. D.F.Malan Drive & Moot Str. Hermanstad,
0082
Tel: 012 377 8300
Pretoria.Service@defy.co.za

Sub-Saharan Africa Service Agents:

ZAMBIA: SOUTHGATE INVESTMENTS LTD

Plot 1606, Sheki Sheki Road
P.O. Box 33681
Lusaka, 10101, Zambia
Tel: +260 0211 242332/3
Fax: +260 0211 242933
sgiservicecentre@microlink.zm

NAMIBIA: ATLANTIC DISTRIBUTORS (PTY) LTD

10 Tienie Louw Street, Northern Industrial Area
P.O. Box 21158, Windhoek, Namibia
Tel: (061) 216162
Fax: (061) 216134
atlantic@mweb.com.na

ZIMBABWE: TRADECOMAFRICA

Trade Com Africa, 183 Loreley Crescent
Msasa, Harare, Zimbabwe
Tel: +263 4 486165/6
Cell: +263 772 469010
Cell: +263 772 469011

BOTSWANA: RAY MORGAN AGENCIES

RMA Service Centre, Plot 48, East Gate
Gaborone International Commerce Park
Kgale View, Gaborone
Botswana
Tel: +267 390 3996 / 390 3912
Fax: +267 318 7376
Cell: +267 7134 6539
service@rma.co.bw; raja@rma.co.bw

SWAZILAND: LYND'S DISTRIBUTORS

P.O Box 716, Mbabane, Swaziland, H100
Tel: (00268) 2515 4310/8
Fax: (00268) 2518 4318

MOZAMBIQUE: COOL WORLD. LDA

Rua da Resistencia No. 97B R/C
Cell: +258 84 44 61 234
coolworldlda@hotmail.com
Nosso Show Room
Av: da Industrias, Parcela No.735 * 735A
Machava, Maputo

**OTHER AREAS ARE SERVICED BY OVER 200 AUTHORISED AGENTS.
FOR FURTHER DETAILS PLEASE CONSULT THE NEAREST REGIONAL
DEFY TECHNICAL SUPPORT CENTRE**

Warranty

This certificate is issued by DEFY APPLIANCES (PTY) LIMITED manufacturers of Defy and Ocean products, hereinafter the Company, to the original purchaser only, of the appliance described on the certificate and shall constitute the only warranty given in respect of this appliance.

The Company warrants to the original purchaser that for a period of TWO YEARS from date of purchase the appliance is free from defect under normal domestic use, both in workmanship and material, subject to the following conditions.

1. Repair or replacement of any part of this appliance, found by the Company to be defective, shall be at the election of the Company. The Company reserves the right to effect such service through any of its Service Divisions or Authorised Service Dealers. The cost of such service shall be borne by the Company in full, provided that the appliance is located no further than 50km from a Company Service Centre or an Authorised Service Dealer. Where the appliance is located beyond the 50km radius, the purchaser shall be liable for the standard travelling charges, as determined by the Company.
2. Vitreous enamelware, fuses and lamps are specifically excluded from these warranties. It is an express condition of these warranties that the purchaser takes due care and attention in the use and maintenance of the appliance. Abuse, misuse in conflict with operating instructions, connection to incorrect voltages and subjection to commercial use shall release the Company from its obligations.
3. This warranty shall become void and cease to operate if the appliance is dismantled by, or any repairs to the appliance are effected by any persons not duly authorised by the Company, or if substitute parts not approved by the Company are used in the appliance, or if the serial number of the appliance is removed.
4. The Company shall not be responsible for damages resulting from fire, flood, civil disturbances or any Act of God. The Company shall not, in terms of these warranties be responsible nor held liable for any consequential loss or damage of any kind caused by or due to the failure or malfunction of the appliance.
5. The Company shall not be responsible for transportation or other costs other than those incurred within the provisions of Point 1 of this Certificate.
6. **For warranties in the Republic of South Africa and Sub-Saharan Africa, please contact your nearest Defy office. Please refer to the previous page for respective South African service agents and Sub-Saharan Africa service agents.**
7. Where service is requested under warranty and no fault or defect can be found by the Company, all costs incurred will be for the purchaser's account.
8. This Certificate as well as your invoice will serve as proof of purchase. For the purpose of warranty, it will be essential to produce this Certificate and invoice. Failure to do so, will render the purchaser liable for service costs.

**KEEP THIS CERTIFICATE AND SALES INVOICE AS PROOF OF
PURCHASE FOR WARRANTY PURPOSES.**